



Dimalog

Digitized
manufacturing
& logistics.

Ketterää materiaalinkäsittelyä Omronin mobiiliroboteilla ja coboteilla

14.9.2022 - Jouni Mononen - Dimalog Oy

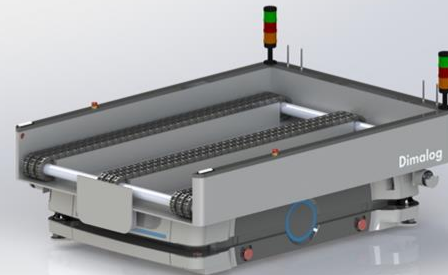

Tarjoamme ratkaisuja logistiikan ja tuotannon tehostamiseen.

OMRON
CERTIFIED
PARTNER

Mobiilirobotit

Yhteistyörobotit

Konenäkö

Teollisuusautomaatio

PILOINTI
JÄRJESTELMÄTOIMITUKSET
TOIMILAITTEET

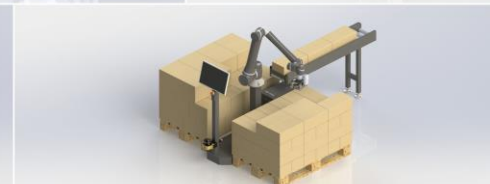
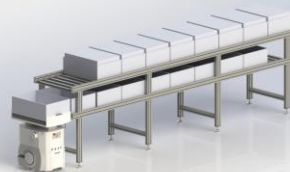
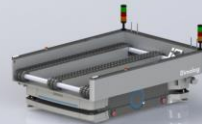

Dimalog

Kutomotie 6 B, 00380 HELSINKI | info@dimalog.com | www.dimalog.com

The Omron AMR solution

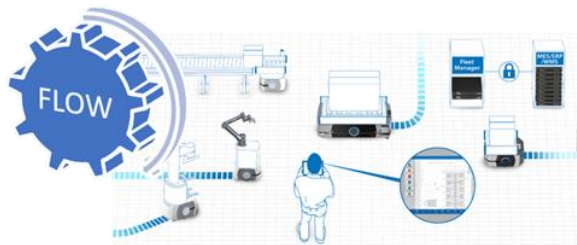

Fleet Management



Mobile Planner



Fleet Simulator



Autonomous Mobile Robots

Industry Leader

OMRON is the world's most popular mobile robot. We've been in the field the longest and have the most installations.

The world's most intelligent Cobot



Integrates the hand, eye and brain into one system

Brain

TMflow™

- Intuitive programming
- All graphic
- SIMPLE to use



Eye

Built-in vision

- Barcode reading, Inspection
- Shape/ color recognition
- SMART vision system

Hand

Collaborative

- Easy to deploy
- Hand-guiding
- SAFE

Model	Payload	Reach
TM5-700	6	700
TM5-900	4	900
TM12	12	1300
TM14	14	1100
TM16	16	900

Omron Flexible Manufacturing –demo

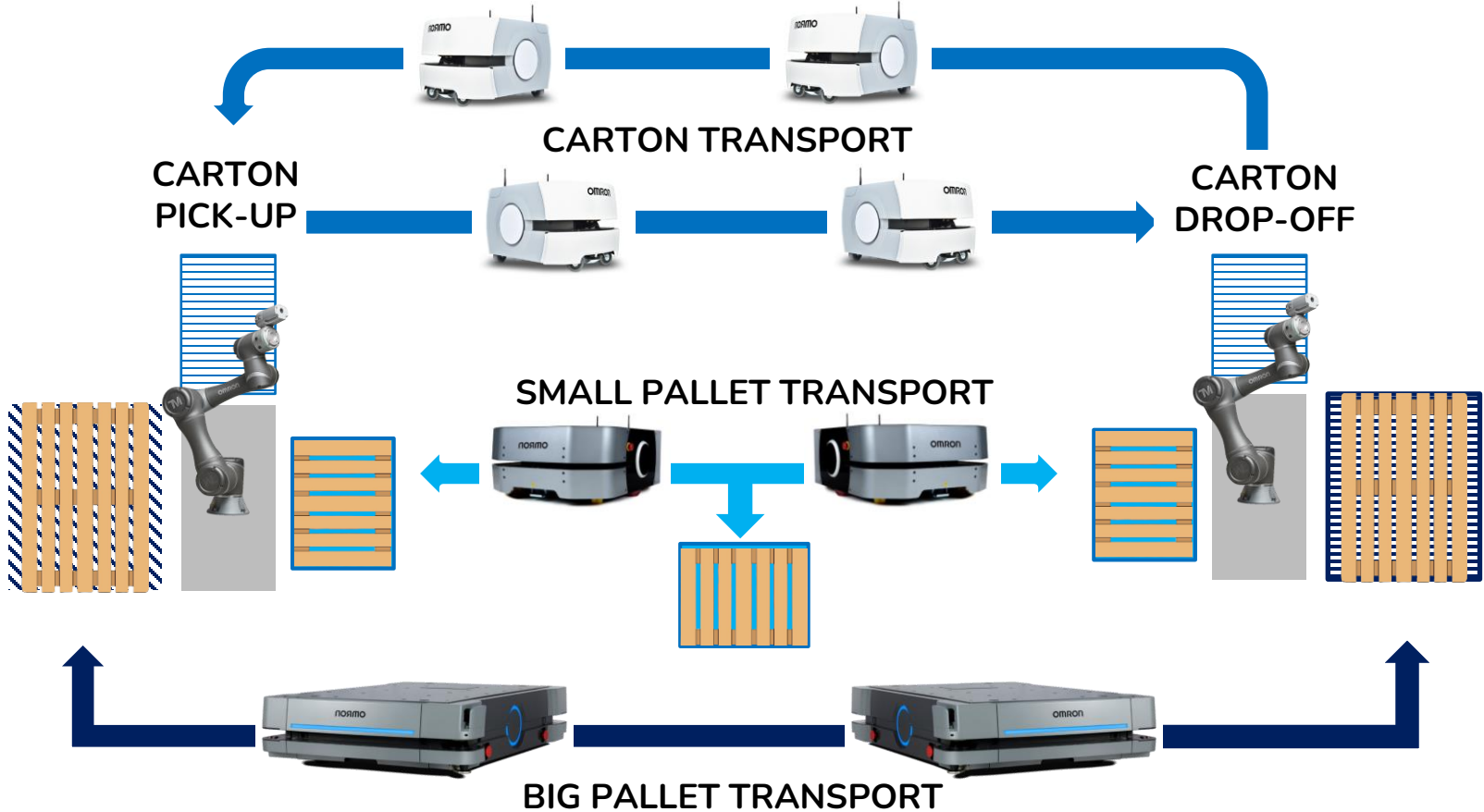



Sisälogistiikan prosesseja

**YKSITTÄISTEN
TUOTTEIDEN/LAATIKOIDEN SIIRTO**

LAVOJEN SIIRTO – KEVYET LAVAT

**LAVOJEN SIIRTO – RASKAAT
LAVAT**

**LAVAUS JA LAVAN PURKU
(PAKKAUS/PURKU)**

KERÄILYKÄRRYJEN SIIRTO

KERÄILY / KITTAUS / HYLLYTYS



Dimalog

Sisälogistiikan prosesseja

**YKSITTÄISTEN
TUOTTEIDEN/LAATIKOIDEN SIIRTO**

LAVOJEN SIIRTO – KEVYET LAVAT

**LAVOJEN SIIRTO – RASKAAT
LAVAT**

**LAVAUS JA LAVAN PURKU
(PAKKAUS/PURKU)**

KERÄILYKÄRRYJEN SIIRTO

KERÄILY / KITTAUS / HYLLYTYS

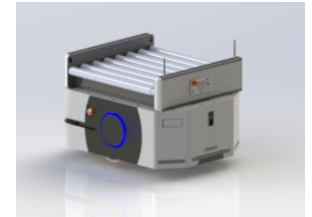
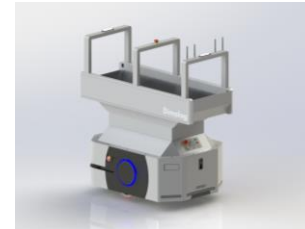
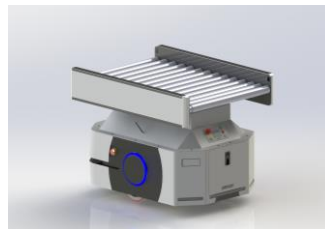

Dimalog

Sisälogistiikan prosesseja

YKSITTÄISTEN
TUOTTEIDEN/LAATIKOIDEN SIIRTO

LAVOJEN SIIRTO – KEVYET LAVAT

LAVOJEN SIIRTO – RASKAAT
LAVAT

LAVAUS JA LAVAN PURKU
(PAKKAUS/PURKU)

KERÄILYKÄRRYJEN SIIRTO

KERÄILY / KITTAUS / HYLLYTYS



Dimalog

Sisälogistiikan prosesseja

YKSITTÄISTEN
TUOTTEIDEN/LAATIKOIDEN SIIRTO

LAVOJEN SIIRTO – KEVYET LAVAT

LAVOJEN SIIRTO – RASKAAT
LAVAT

LAVAUS JA LAVAN PURKU
(PAKKAUS/PURKU)

KERÄILYKÄRRYJEN SIIRTO

KERÄILY / KITTAUS / HYLLYTYS

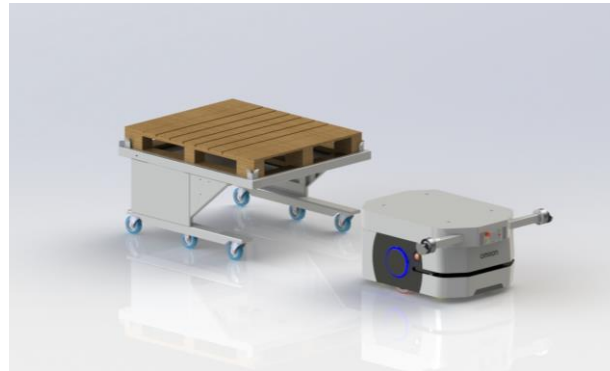
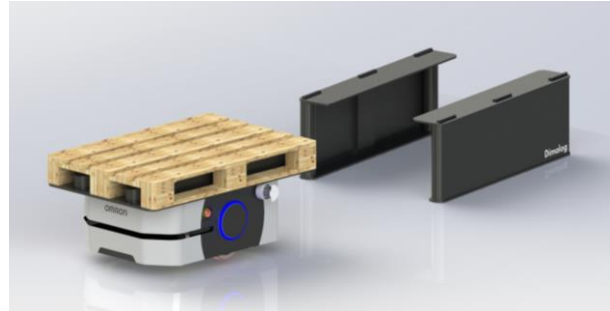

Dimalog

Sisälogistiikan prosesseja

YKSITTÄISTEN
TUOTTEIDEN/LAATIKOIDEN SIIRTO

LAVOJEN SIIRTO – KEVYET LAVAT

LAVOJEN SIIRTO – RASKAAT
LAVAT

LAVAUS JA LAVAN PURKU
(PAKKAUS/PURKU)

KERÄILYKÄRRYJEN SIIRTO

KERÄILY / KITTAUS / HYLLYTYS



Dimalog

Sisälogistiikan prosesseja

YKSITTÄISTEN
TUOTTEIDEN/LAATIKOIDEN SIIRTO

LAVOJEN SIIRTO – KEVYET LAVAT

LAVOJEN SIIRTO – RASKAAT
LAVAT

LAVAUS JA LAVAN PURKU
(PAKKAUS/PURKU)

KERÄILYKÄRRYJEN SIIRTO

KERÄILY / KITTAUS / HYLLYTYS

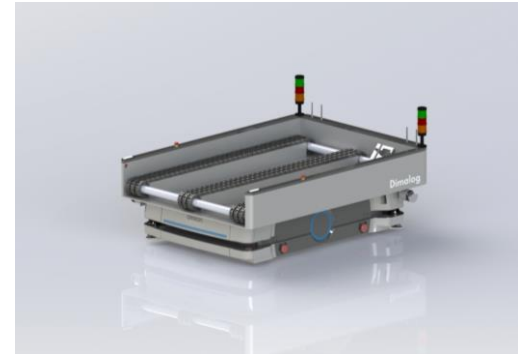
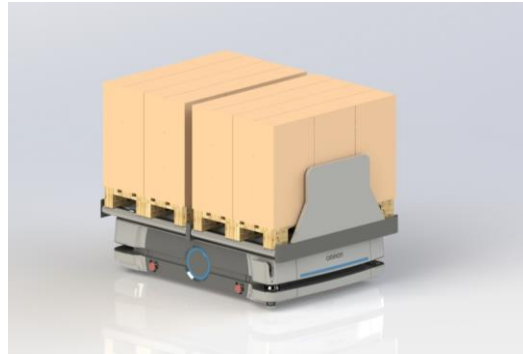

Dimalog

Sisälogistiikan prosesseja

YKSITTÄISTEN
TUOTTEIDEN/LAATIKOIDEN SIIRTO

LAVOJEN SIIRTO – KEVYET LAVAT

LAVOJEN SIIRTO – RASKAAT
LAVAT

LAVAUS JA LAVAN PURKU
(PAKKAUS/PURKU)

KERÄILYKÄRRYJEN SIIRTO

KERÄILY / KITTAUS / HYLLYTYS



Dimalog

Sisälogistiikan prosesseja

YKSITTÄISTEN
TUOTTEIDEN/LAATIKOIDEN SIIRTO

LAVOJEN SIIRTO – KEVYET LAVAT

LAVOJEN SIIRTO – RASKAAT
LAVAT

LAVAUS JA LAVAN PURKU
(PAKKAUS/PURKU)

KERÄILYKÄRRYJEN SIIRTO

KERÄILY / KITTAUS / HYLLYTYS

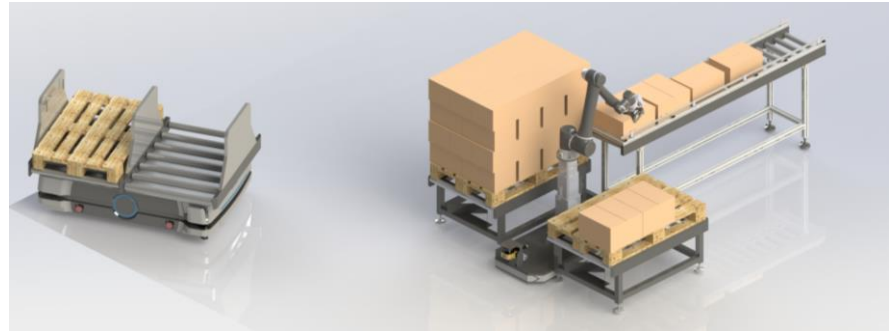
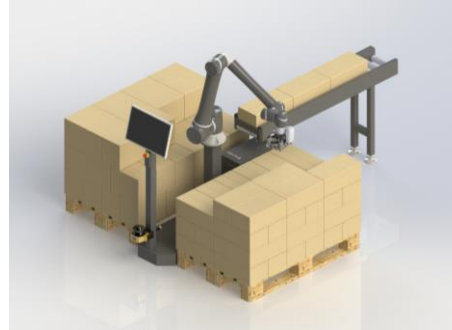

Dimalog

Sisälogistiikan prosesseja

YKSITTÄISTEN
TUOTTEIDEN/LAATIKOIDEN SIIRTO

LAVOJEN SIIRTO – KEVYET LAVAT

LAVOJEN SIIRTO – RASKAAT
LAVAT

LAVAUS JA LAVAN PURKU
(PAKKAUS/PURKU)

KERÄILYKÄRRYJEN SIIRTO

KERÄILY / KITTAUS / HYLLYTYS

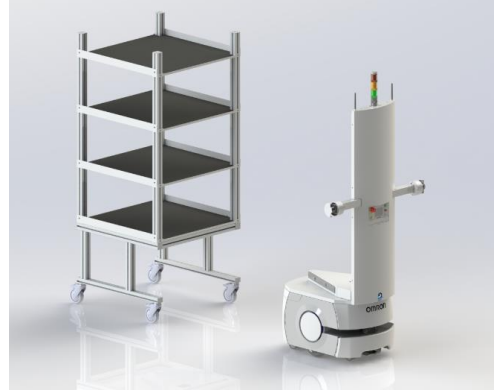

Dimalog

Sisälogistiikan prosesseja

YKSITTÄISTEN
TUOTTEIDEN/LAATIKOIDEN SIIRTO

LAVOJEN SIIRTO – KEVYET LAVAT

LAVOJEN SIIRTO – RASKAAT
LAVAT

LAVAUS JA LAVAN PURKU
(PAKKAUS/PURKU)

KERÄILYKÄRRYJEN SIIRTO

KERÄILY / KITTAUS / HYLLYTYS

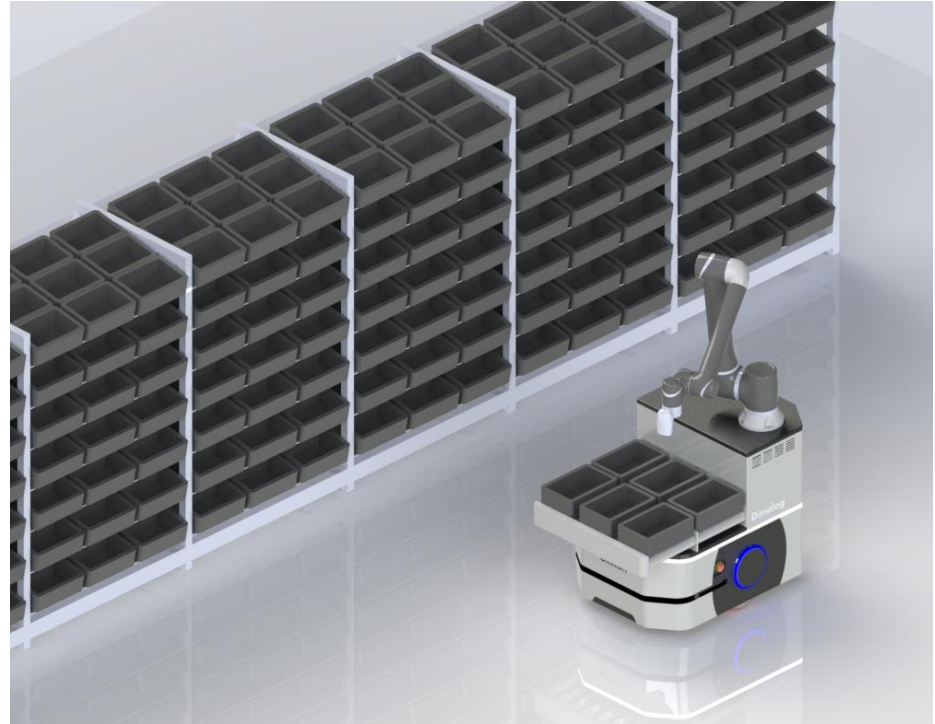

Dimalog



Kiitos!

Jouni Mononen

jouni.mononen@dimalog.com

+358 50 5341 472

www.dimalog.com

